

TOSHIBA LED Lamps

TLRF1060(T18), TLSF1060(T18), TLOF1060(T18), TLYF1060(T18), TLPYF1060(T18), TLGF1060(T18), TLFGF1060(T18), TLPGF1060(T18)

Panel Circuit Indicator

Unit: mm

- Surface-mount devices
- 2.2 (L) × 1.4 (W) × 1.3 (H) mm
- Flat-top type
- InGaAlP LEDs
- High luminous intensity
- Low drive current, high-intensity light emission
- Colors: red, orange, yellow, green, pure green
- Pb free reflow soldering is possible
- Applications: automotive use, message signboards, backlighting etc.
- Standard embossed tape packing: T18 (3000/reel)
 8-mm tape reel

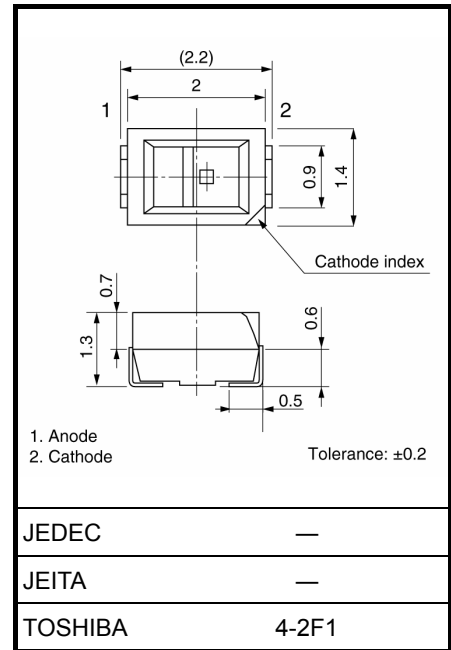

Weight: 0.01 g (typ.)

Color and Material

Product Name	Color	Material
TLRF1060	Red	InGaAlP
TLSF1060	Red	
TLOF1060	Orange	
TLYF1060	Yellow	
TLPYF1060	Yellow	
TLGF1060	Green	
TLFGF1060	Green	
TLPGF1060	Pure Green	

Maximum Ratings (Ta = 25°C)

Product Name	Forward Current I _F (mA) Please see Note 1	Reverse Voltage V _R (V)	Power Dissipation P _D (mW)	Operation Temperature T _{opr} (°C)	Storage Temperature T _{stg} (°C)
TLRF1060	30	15	75	-40~100	-40~100
TLSF1060					
TLOF1060					
TLYF1060					
TLPYF1060					
TLGF1060					
TLFGF1060					
TLPGF1060					

Note 1: Forward current derating

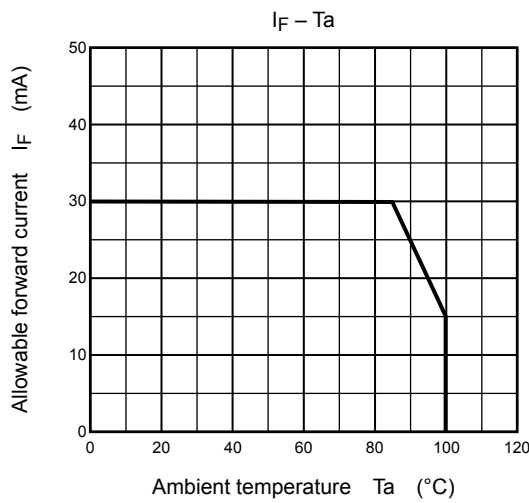

Electrical Characteristics (Ta = 25°C)

Product Name	Forward Voltage V _F				Reverse Current I _R	
	Min	Typ.	Max	I _F	Max	V _R
TLRF1060	1.7	2.0	2.5	20	10	15
TLSF1060	1.7	2.0	2.5			
TLOF1060	1.7	2.0	2.5			
TLYF1060	1.7	2.1	2.5			
TLPYF1060	1.7	2.1	2.5			
TLGF1060	1.7	2.2	2.5			
TLFGF1060	1.7	2.2	2.5			
TLPGF1060	1.7	2.2	2.5			
Unit	V			mA	μA	V

Optical Characteristics-1 (Ta = 25°C)

Product Name	Luminous Intensity I _v				Available I _v rank Please see Note 2
	Min	Typ.	Max	I _F	
TLRF1060	40	100	320	20	PA / QA / RA / SA
TLSF1060	100	200	500	20	RA / SA / TA
TLOF1060	100	220	500	20	RA / SA / TA
TLYF1060	63	180	320	20	QA / RA / SA
TLPYF1060	40	100	320	20	PA / QA / RA / SA
TLGF1060	40	80	320	20	PA / QA / RA / SA
TLFGF1060	25	50	125	20	NA / PA / QA
TLPGF1060	10	20	50	20	LA / MA / NA
Unit	mcd			mA	

Note 2: The specification on the above table is used for I_v classification of LEDs in Toshiba facility.
Each reel includes the same rank LEDs. Let the delivery ratio of each rank be unquestioned.

Rank	Luminous Intensity I _v	
	Min	Max
LA	10	20
MA	16	32
NA	25	50
PA	40	80
QA	63	125
RA	100	200
SA	160	320
TA	250	500
Unit	mcd	mcd

Optical Characteristics-2 (Ta = 25°C)

Product Name	Emission Spectrum							I _F
	Peak Emission Wavelength λ _p			Δλ Typ.	Dominant Wavelength λ _d			
	Min	Typ.	Max		Min	Typ.	Max	
TLRF1060	—	644	—	18	624	630	638	20
TLSF1060	—	623	—	17	607	613	621	
TLOF1060	—	612	—	15	599	605	613	
TLYF1060	—	590	—	13	580	587	595	
TLPYF1060	—	583	—	13	574	580	586	
TLGF1060	—	574	—	11	565	571	576	
TLFGF1060	—	568	—	11	565	565	565	
TLPGF1060	—	562	—	11	555	558	564	
Unit	nm			nm	nm			mA

The cautions

- This visible LED lamp also emits some IR light.
If a photodetector is located near the LED lamp, please ensure that it will not be affected by the IR light.
- This product is designed as a general display light source usage, and it has applied the measurement standard that matched with the sensitivity of human's eyes. Therefore, it is not intended for usage of functional application (ex. Light source for sensor, optical communication and etc) except general display light source.

TLRF1060

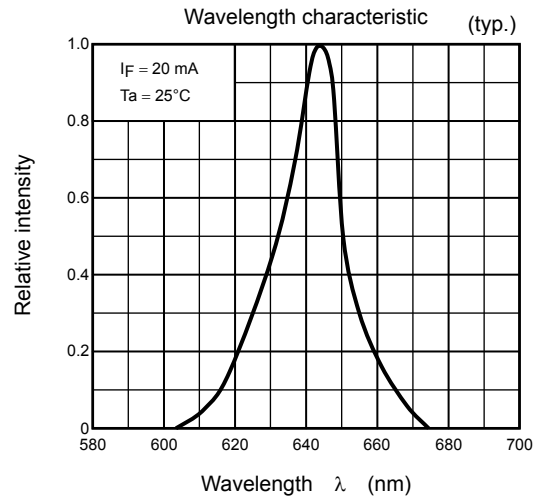
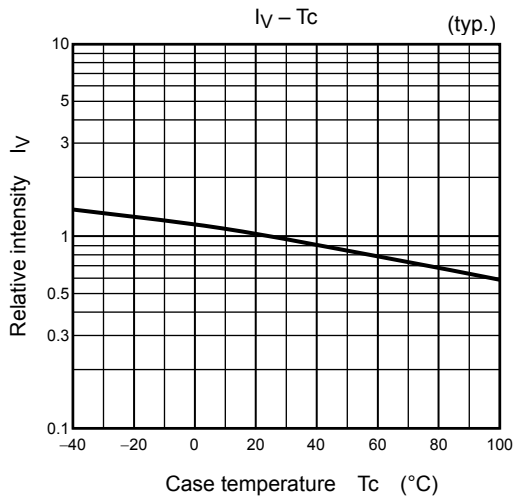
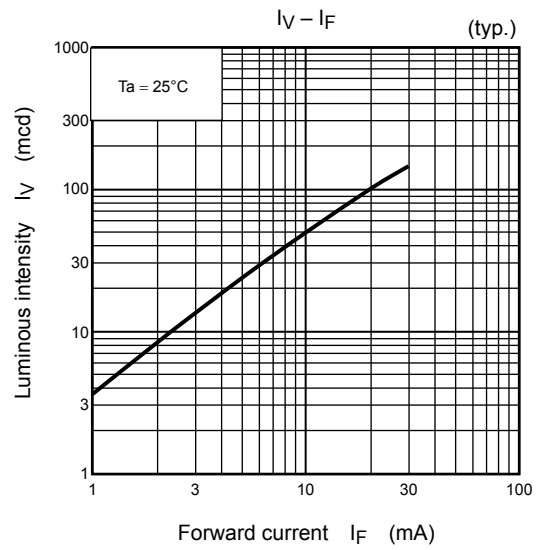
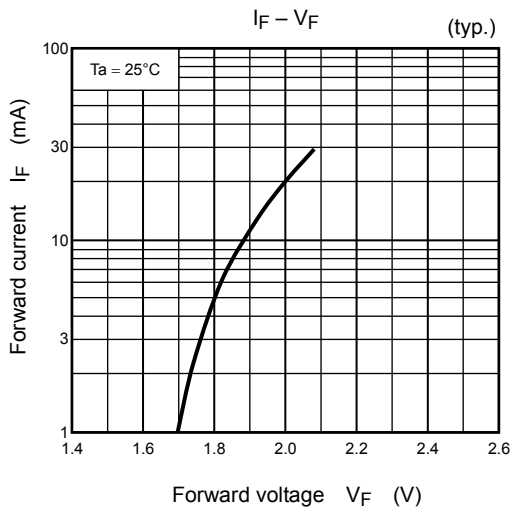

Radiation pattern

$T_a = 25^\circ\text{C}$
(typ.)

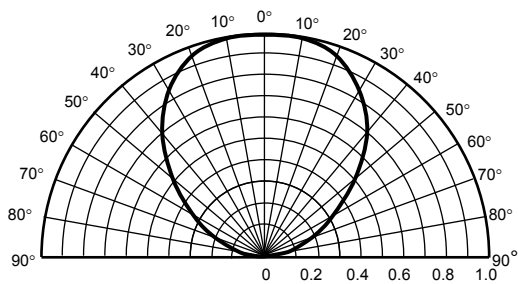

TLSF1060

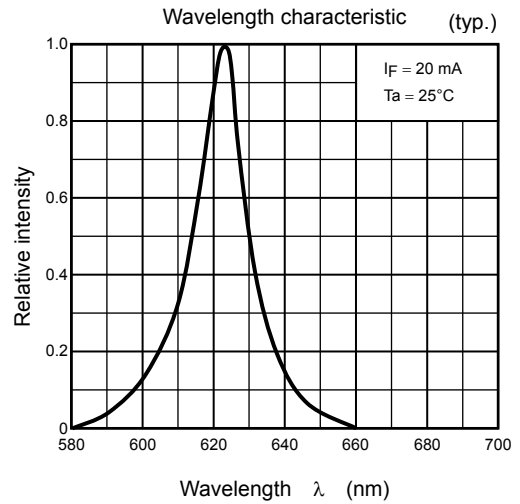
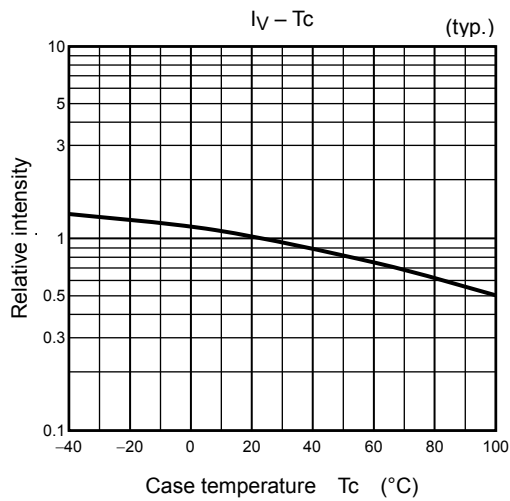
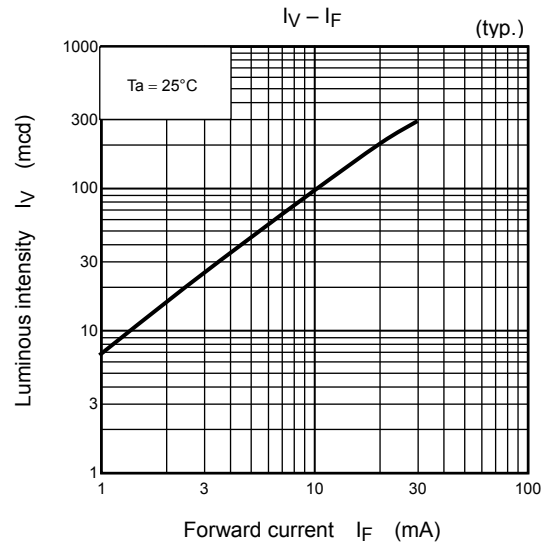
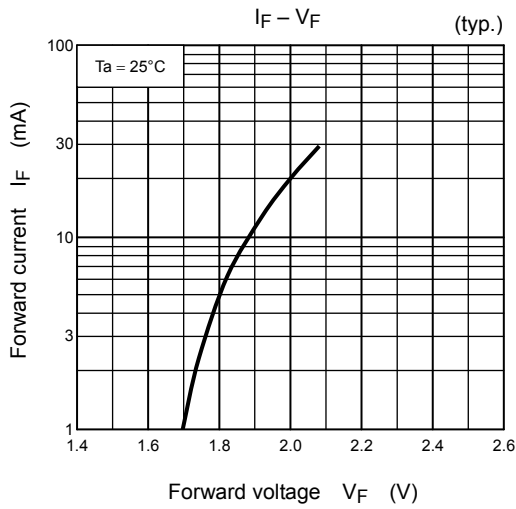

Radiation pattern

$T_a = 25^\circ\text{C}$
(typ.)

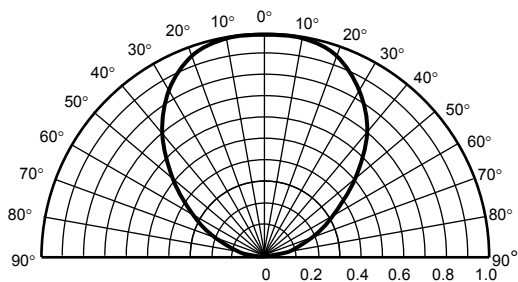

TLOF1060

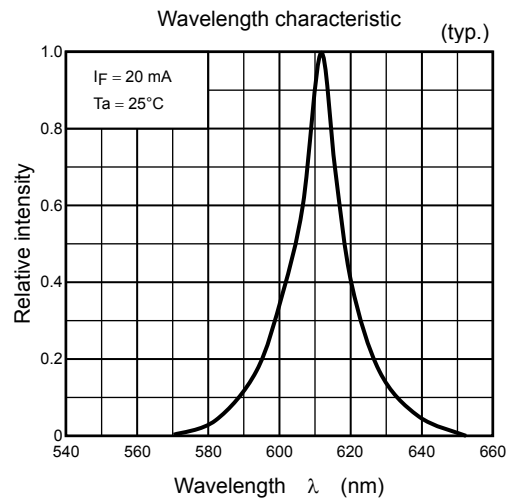
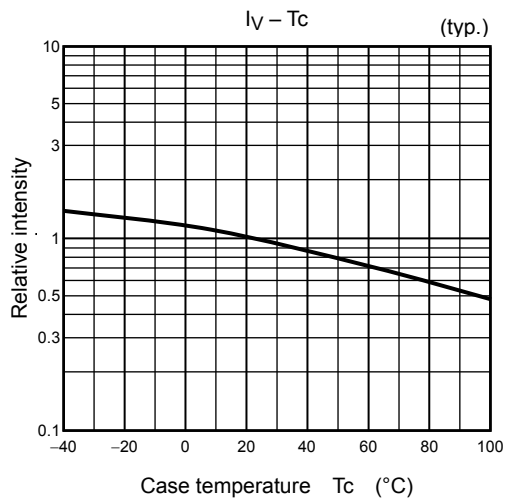
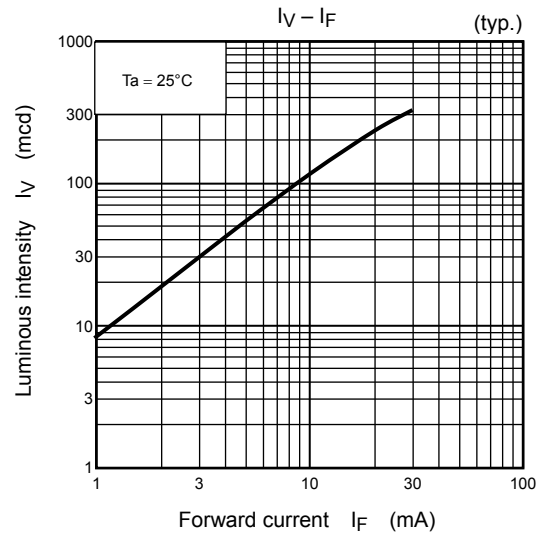
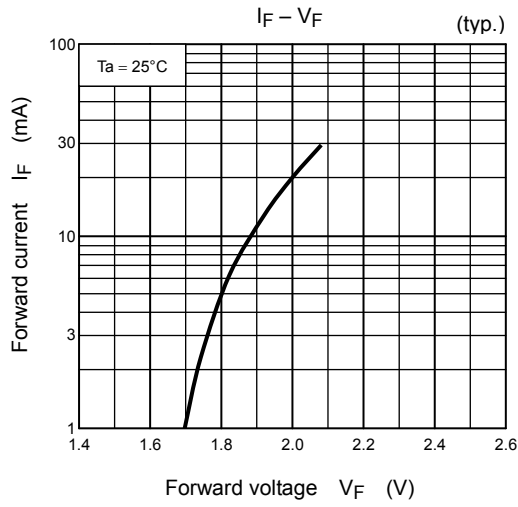

Radiation pattern

$T_a = 25^\circ\text{C}$
(typ.)

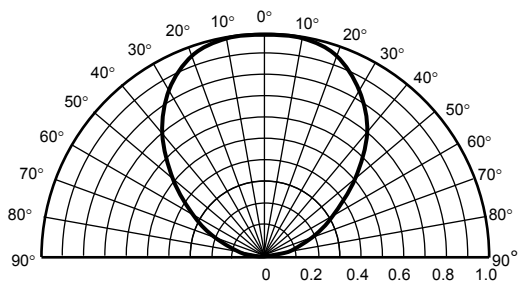

TLYF1060

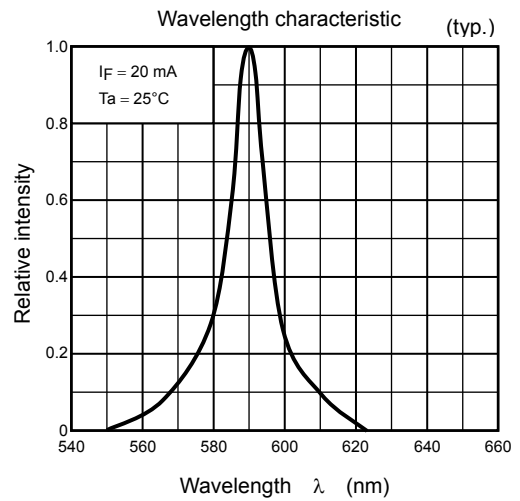
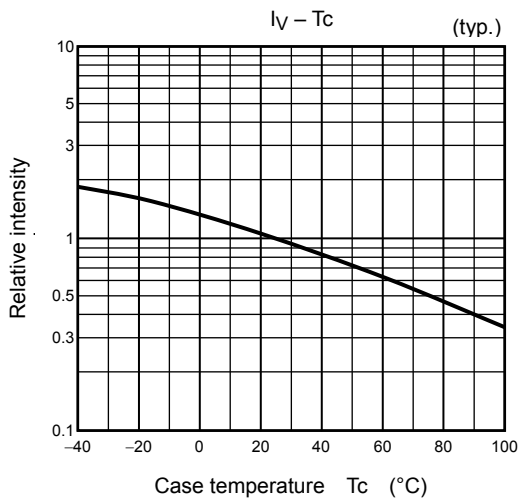
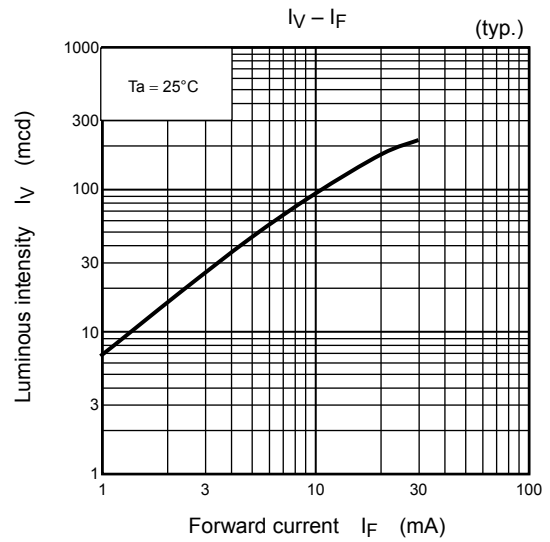
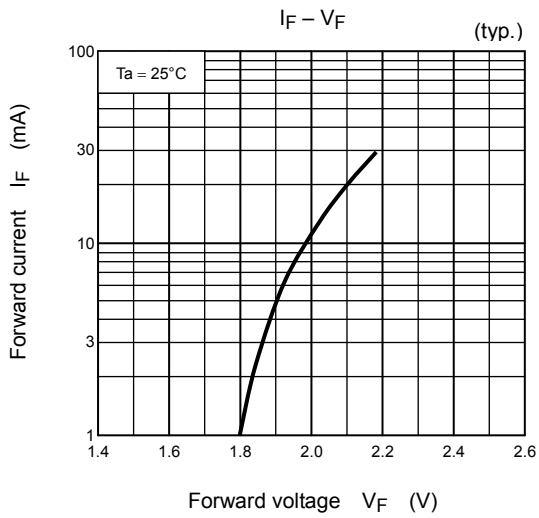

Radiation pattern

$T_a = 25^\circ\text{C}$
(typ.)

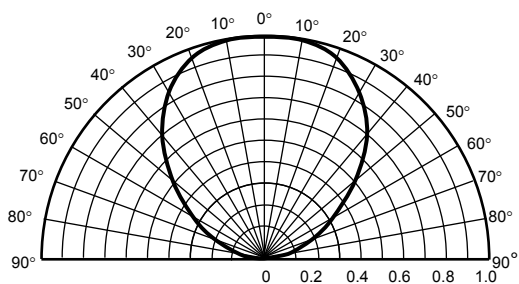

TLPYF1060

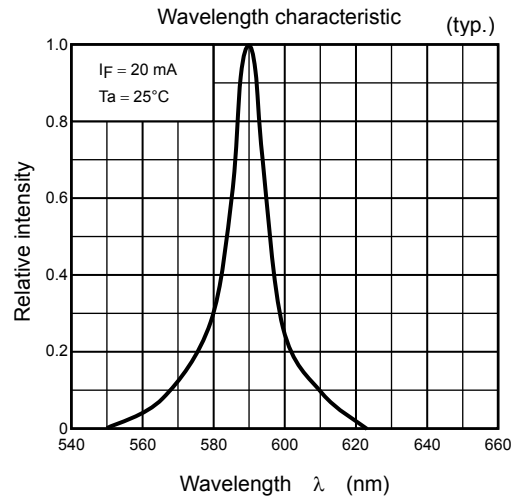
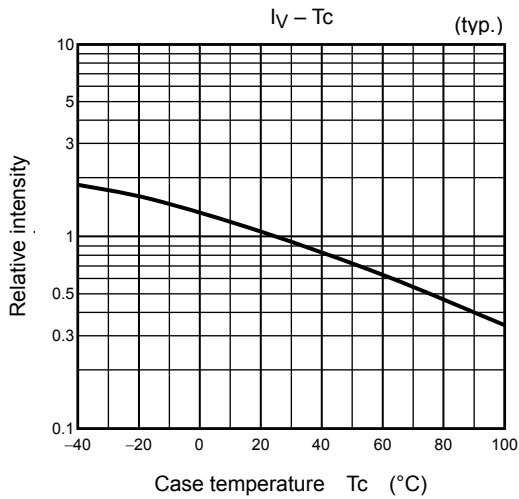
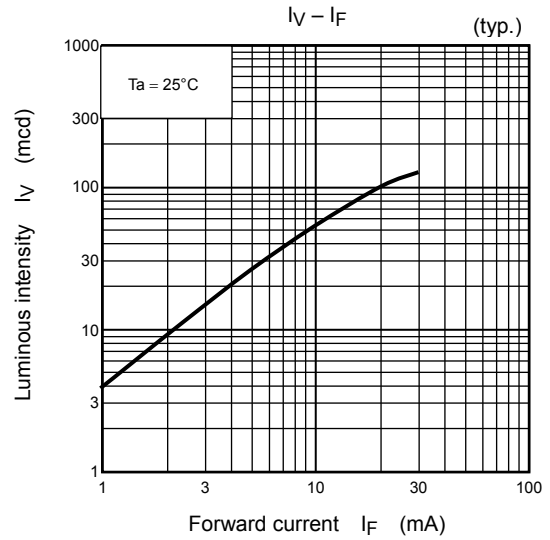
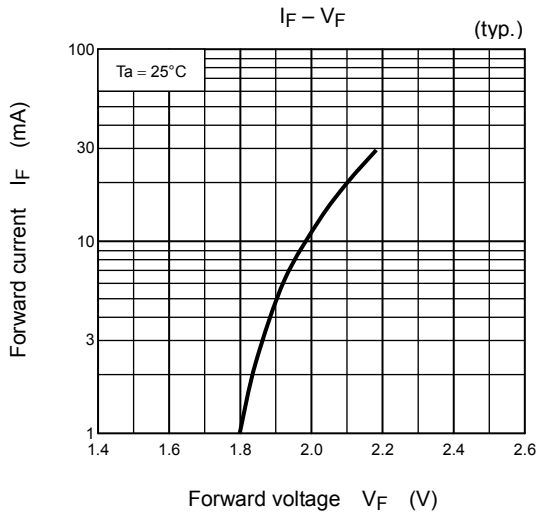

Radiation pattern

$T_a = 25^\circ\text{C}$
(typ.)

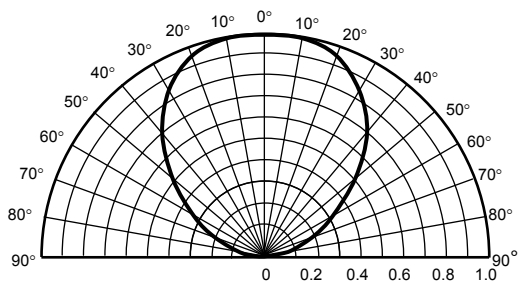

TLGF1060

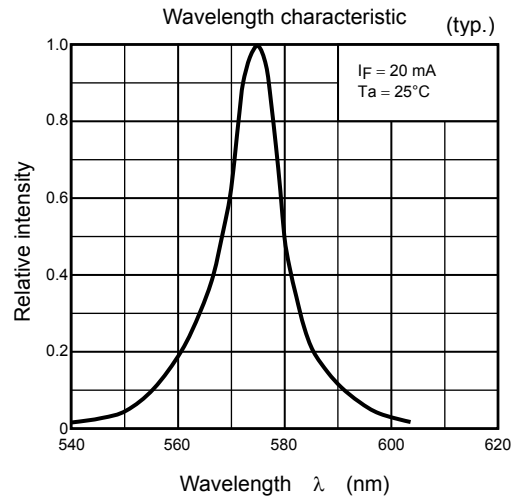
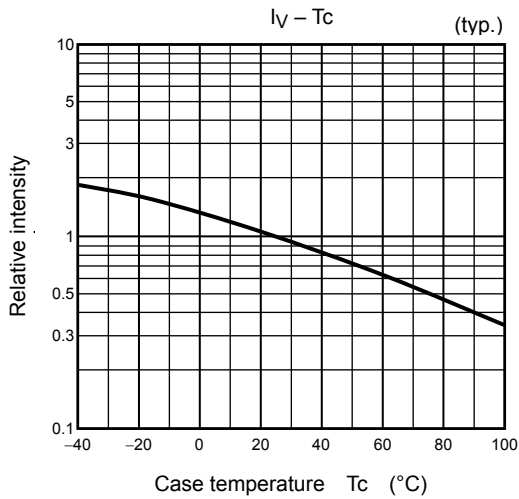
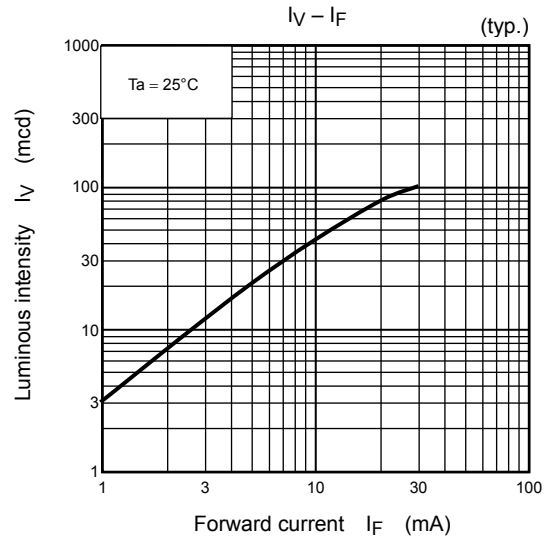
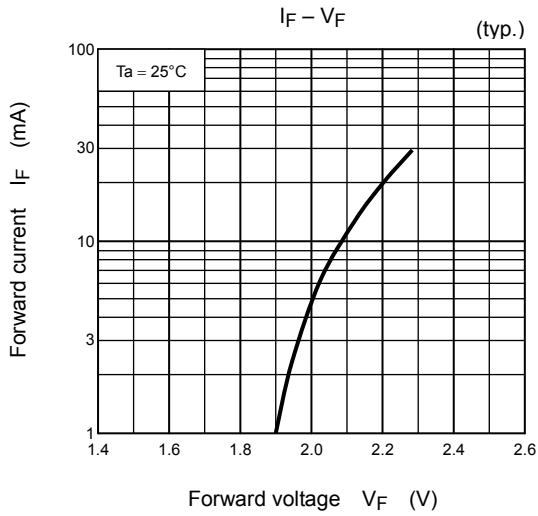

Radiation pattern

$T_a = 25^\circ\text{C}$
(typ.)

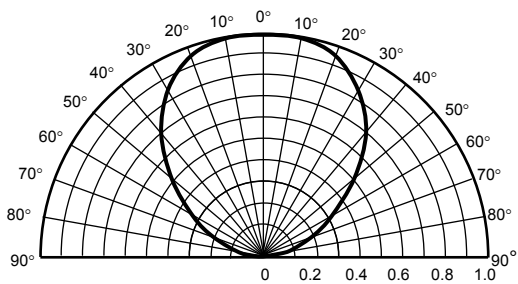

TLFGF1060

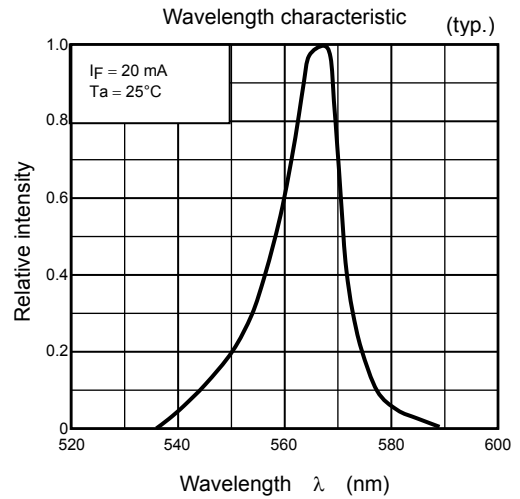
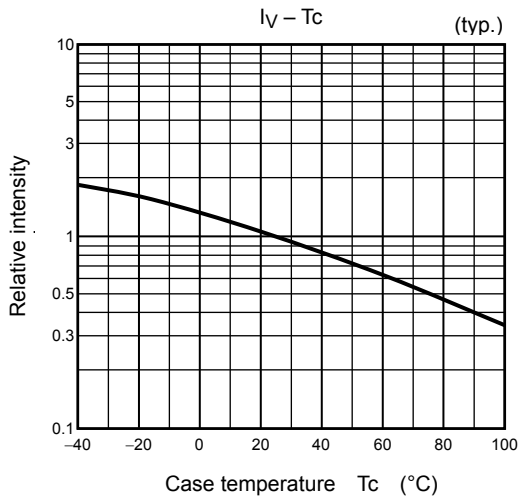
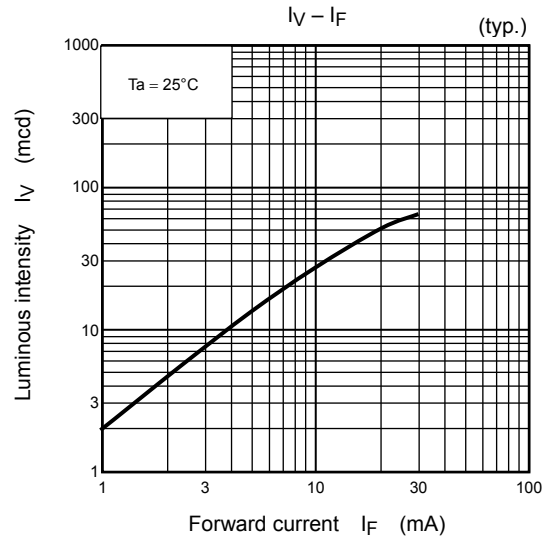
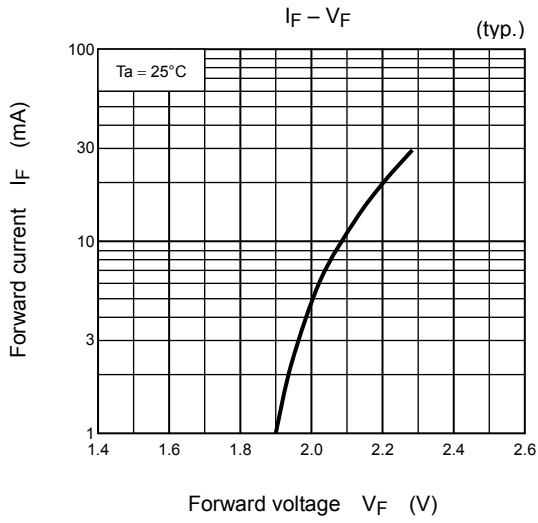

Radiation pattern

$T_a = 25^\circ\text{C}$
(typ.)

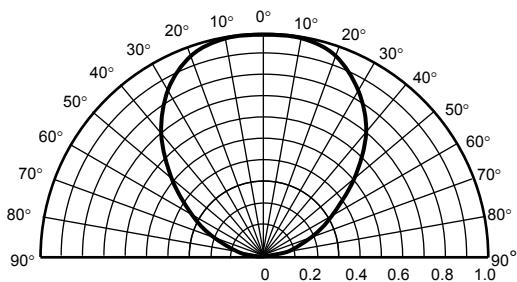

TLPGF1060

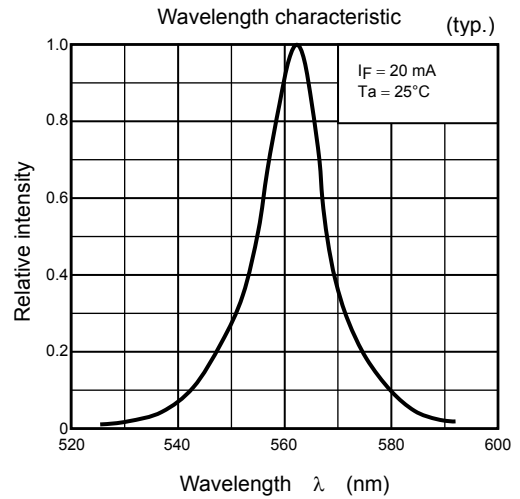
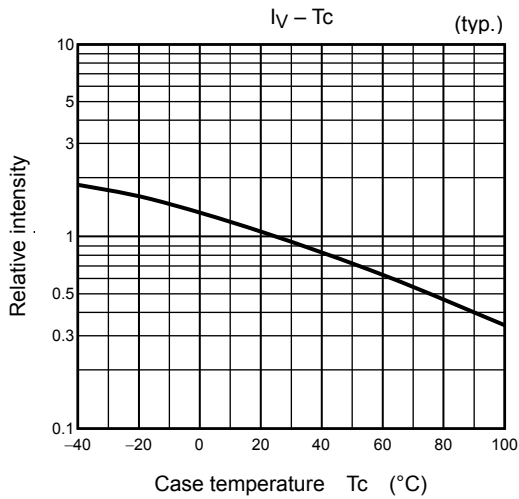
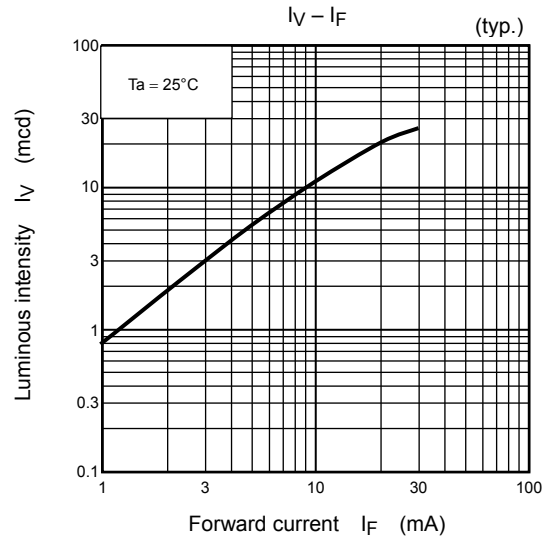
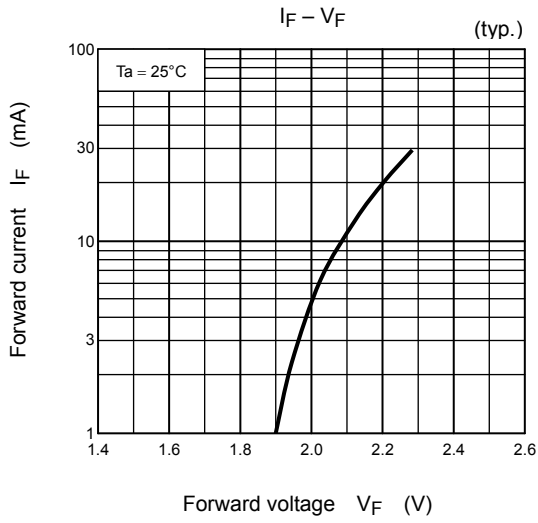

Radiation pattern

$T_a = 25^\circ\text{C}$
(typ.)

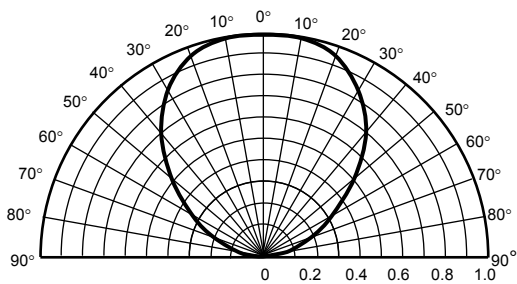

Packaging

These LED devices are packed in an aluminum envelope with a silica gel and a moisture indicator to avoid moisture absorption. The optical characteristics of the devices may be affected by exposure to moisture in the air before soldering and they should therefore be stored under the following conditions:

1. This moisture proof bag may be stored unopened within 12 months at the following conditions.
 Temperature: 5°C~30°C
 Humidity: 90% (max)
2. After opening the moisture proof bag, the devices should be assembled within 168 hours in an environment of 5°C to 30°C/60% RH or below.
3. If upon opening, the moisture indicator card shows humidity 30% or above (Color of indication changes to pink) or the expiration date has passed, the devices should be baked in taping with reel.
 After baking, use the baked devices within 72 hours, but perform baking only once.
 Baking conditions: 60±5°C, for 12 to 24 hours.
 Expiration date: 12 months from sealing date, which is imprinted on the label.
4. Repeated baking can cause the peeling strength of the taping to change, then leads to trouble in mounting. Furthermore, prevent the devices from being destructed against static electricity for baking of it.
5. If the packing material of laminate would be broken, the hermeticity would deteriorate. Therefore, do not throw or drop the packed devices.

Mounting Method

Soldering

- Reflow soldering

Temperature profile for Pb soldering (example)

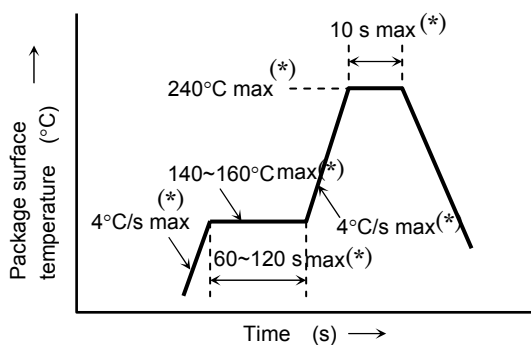

Temperature profile for Pb-free soldering (example)

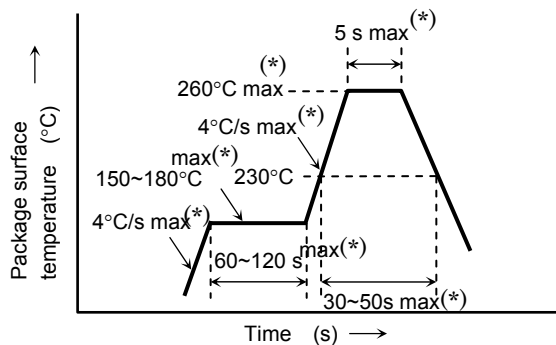

- The products are evaluated using above reflow soldering conditions. No additional test is performed exceed the condition (i.e. the condition more than (*)MAX values) as a evaluation. Please perform reflow soldering under the above conditions.
- Please perform the first reflow soldering with reference to the above temperature profile and within 168 h of opening the package.
- Second reflow soldering
 In case of second reflow soldering should be performed within 168 h of the first reflow under the above conditions.
 Storage conditions before the second reflow soldering: 30°C, 60% RH (max)
- Make any necessary soldering corrections manually.
 (only once at each soldering point)
 Soldering iron: 25 W
 Temperature : 300°C or less
 Time : within 3 s
- Do not perform wave soldering.

Recommended soldering pattern

Unit: mm

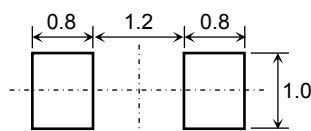

Cleaning

When cleaning is required after soldering, Toshiba recommends the following cleaning solvents. It is confirmed that these solvents have no effect on semiconductor devices in our dipping test (under the recommended conditions). In selecting the one for your actual usage, please perform sufficient review on washing condition, using condition and etc.

ASAHI CLEAN AK-225AES	: (made by ASAHI GLASS)
KAO CLEAN TROUGH 750H	: (made by KAO)
PINE ALPHA ST-100S	: (made by ARAKAWA CHEMICAL)
TOSHIBA TECHNOCARE (FRW-17, FRW-1, FRV-100)	: (made by GE TOSHIBA SILICONES)

Precautions when Mounting

Do not apply force to the plastic part of the LED under high-temperature conditions. To avoid damaging the LED plastic, do not apply friction using a hard material. When installing the PCB in a product, ensure that the device does not come into contact with other components.

Tape Specifications

1. Product number format

The type of package used for shipment is denoted by a symbol suffix after the product number. The method of classification is as below. (this method, however does not apply to products whose electrical characteristics differ from standard Toshiba specifications)

- (1) Tape Type: T18 (4-mm pitch)
- (2) Example

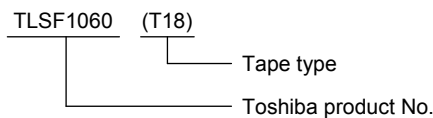

2. Tape dimensions

Unit: mm

Symbol	Dimension	Tolerance
D	1.5	+0.1/-0
E	1.75	±0.1
P ₀	4.0	±0.1
t	0.2	±0.05
F	3.5	±0.05
D ₁	1.1	±0.1

Symbol	Dimension	Tolerance
P ₂	2.0	±0.05
W	8.0	±0.2
P	4.0	±0.1
A ₀	1.5	±0.1
B ₀	2.5	±0.1
K ₀	1.5	±0.1

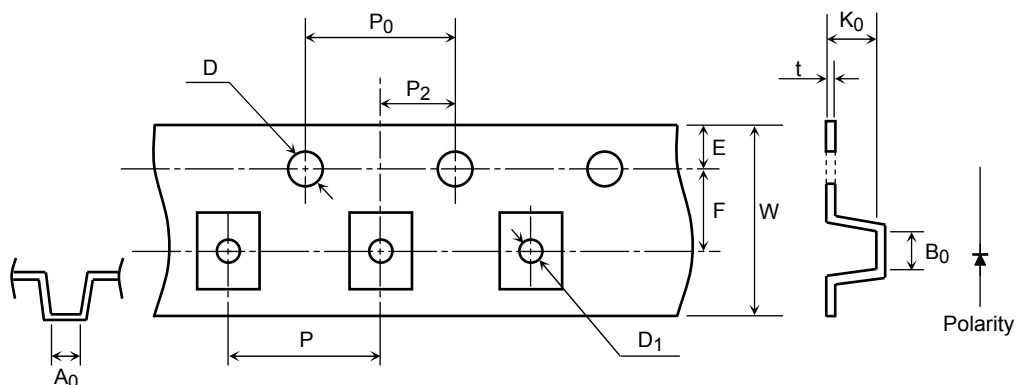

3. Reel dimensions

Unit: mm

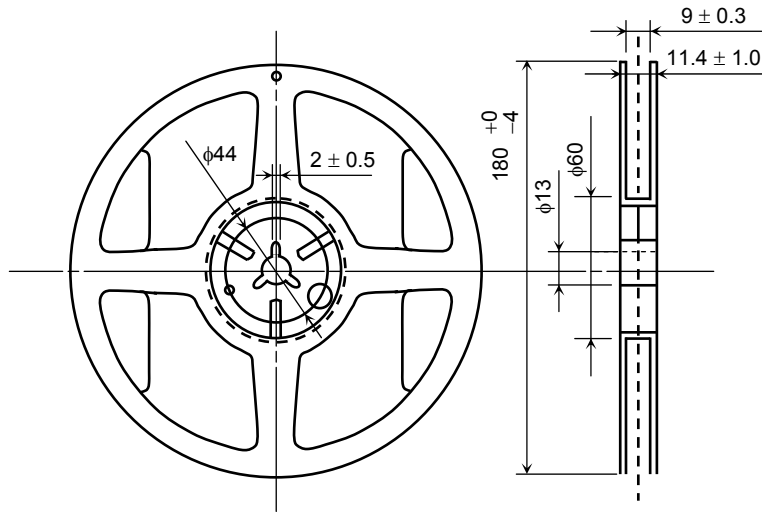

4. Leader and trailer sections of tape

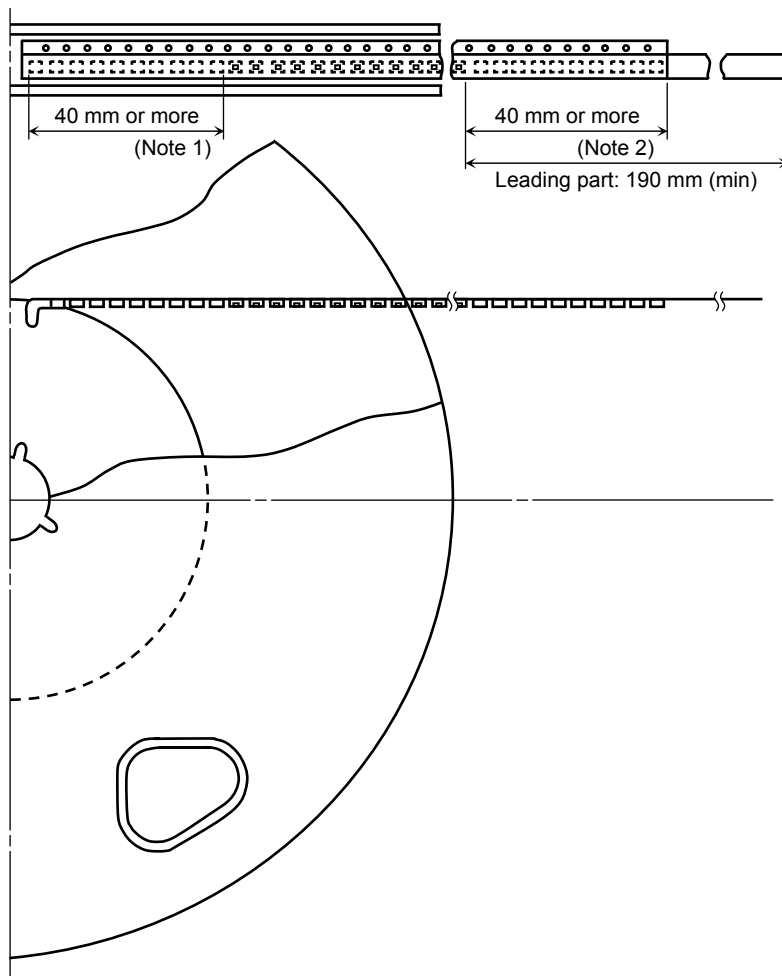

Note1: Empty trailer section

Note2: Empty leader section

5. Packing display



(1) Packing quantity

Reel	3,000 pcs
Carton	15,000 pcs

(2) Packing form: Each reel is sealed in an aluminum pack with silica gel.

6. Label format

(1) Example: TLSF1060 (T18)

P/N:				 
TYPE	TLSF1060			
ADDC	(T18)	Q'TY	3,000 pcs	

Lot Number Key code for TSB 32C 3000
(RANK SYMBOL)

Use under 5-30degC/60%RH within 168h

[[G]]/RoHS COMPATIBLE	SEAL DATE: *****
Y3804xxxxxxxxxxxxxxxxx	DIFFUSED IN *****
	ASSEMBLED IN *****



(2) Label location

- Reel

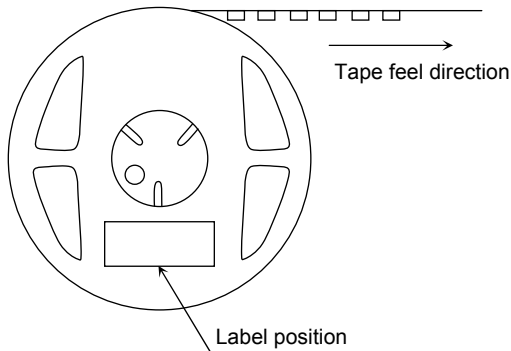

- Carton

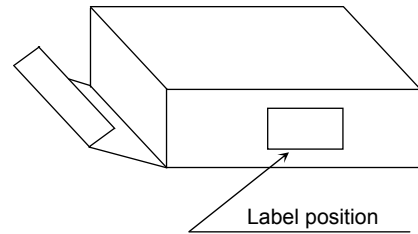

- The aluminum package in which the reel is supplied also has the label attached to center of one side.

RESTRICTIONS ON PRODUCT USE

20070701-EN

- The information contained herein is subject to change without notice.
- TOSHIBA is continually working to improve the quality and reliability of its products. Nevertheless, semiconductor devices in general can malfunction or fail due to their inherent electrical sensitivity and vulnerability to physical stress. It is the responsibility of the buyer, when utilizing TOSHIBA products, to comply with the standards of safety in making a safe design for the entire system, and to avoid situations in which a malfunction or failure of such TOSHIBA products could cause loss of human life, bodily injury or damage to property.
In developing your designs, please ensure that TOSHIBA products are used within specified operating ranges as set forth in the most recent TOSHIBA products specifications. Also, please keep in mind the precautions and conditions set forth in the "Handling Guide for Semiconductor Devices," or "TOSHIBA Semiconductor Reliability Handbook" etc.
- The TOSHIBA products listed in this document are intended for usage in general electronics applications (computer, personal equipment, office equipment, measuring equipment, industrial robotics, domestic appliances, etc.). These TOSHIBA products are neither intended nor warranted for usage in equipment that requires extraordinarily high quality and/or reliability or a malfunction or failure of which may cause loss of human life or bodily injury ("Unintended Usage"). Unintended Usage include atomic energy control instruments, airplane or spaceship instruments, transportation instruments, traffic signal instruments, combustion control instruments, medical instruments, all types of safety devices, etc.. Unintended Usage of TOSHIBA products listed in this document shall be made at the customer's own risk.
- The products described in this document shall not be used or embedded to any downstream products of which manufacture, use and/or sale are prohibited under any applicable laws and regulations.
- The information contained herein is presented only as a guide for the applications of our products. No responsibility is assumed by TOSHIBA for any infringements of patents or other rights of the third parties which may result from its use. No license is granted by implication or otherwise under any patents or other rights of TOSHIBA or the third parties.
- GaAs(Gallium Arsenide) is used in this product. The dust or vapor is harmful to the human body. Do not break, cut, crush or dissolve chemically.
- Please contact your sales representative for product-by-product details in this document regarding RoHS compatibility. Please use these products in this document in compliance with all applicable laws and regulations that regulate the inclusion or use of controlled substances. Toshiba assumes no liability for damage or losses occurring as a result of noncompliance with applicable laws and regulations.